

TOP VIEW

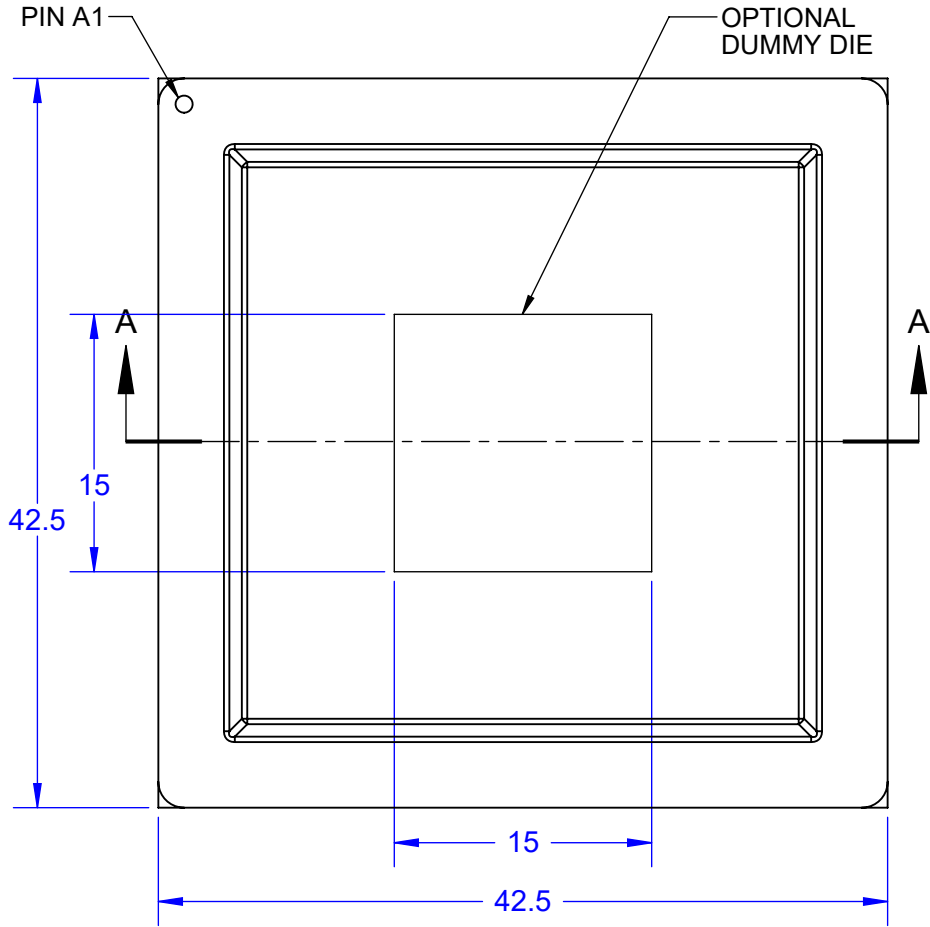

BALL VIEW

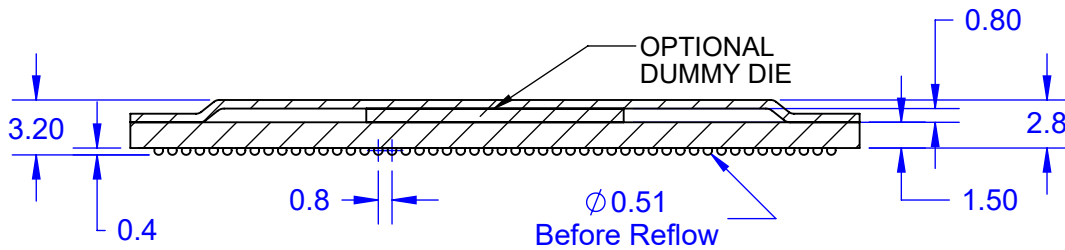
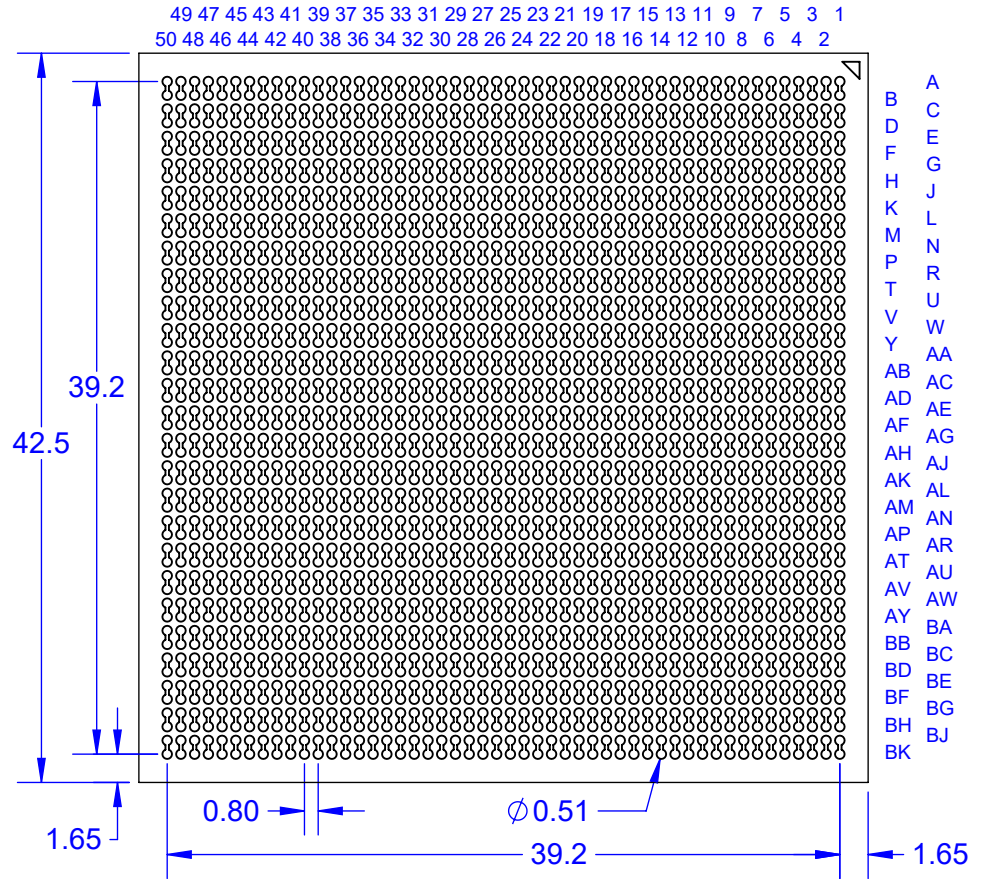

SECTION A-A

Notes: (Unless Otherwise Specified).

- 1) ALL DIMENSIONS ARE IN MM.
- 2) SOLDER BALL ALLOY: SEE PART NUMBER TABLE.
- 3) BALL DIAMETER (BEFORE REFLOW): 0.51mm (20 MIL).
- 4) SOLDER MASK DEFINED PAD OPENING: 0.45mm (17.7 MIL).
- 5) PAD Cu DIAMETER: 0.61mm (24 MIL).
- 6) SUBSTRATE MATERIAL: BT
- 7) DUMMY DIE IS OPTIONAL.
- 8) DAISY CHAIN PATTERN (SEE PAGE 2).
- 9) MSL-3 RECOMMENDED BAKING 24 HOURS @ 125°C TO REMOVE MOISTURE PRIOR SOLDERING TO PC BOARD.

PART NUMBER TABLE

PART NUMBER	BALL ALLOY	Pb-Free	RoHS	Si DIE
SBGA2500T.8C-DC508D	Sn96.5/Ag3.0/Cu0.5	YES	YES	YES
SBGA2500T.8-DC508D	Sn63/Pb37	NO	NO	YES

APPROVALS	DATE	<b>TopLine®</b>		
DRAWN T. Au	8/22/2024			
ENG M. Hart	8/22/2024	TITLE		SBGA2500T.8-DC508D DAISY CHAIN DUMMY
MFG		SCALE	SIZE	DRAWING NO.
QA		1.8:1	A	585085
CUST				REV A
REVISED		DO NOT SCALE DRAWING		SHEET 1 OF 10

### BALL VIEW

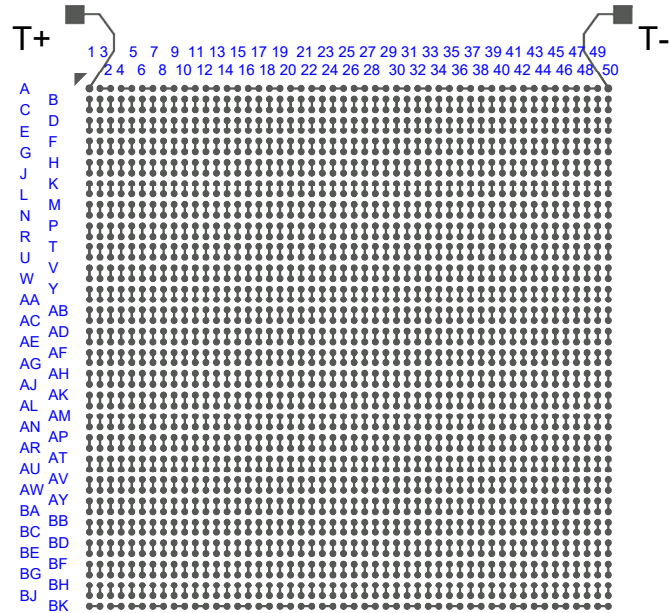
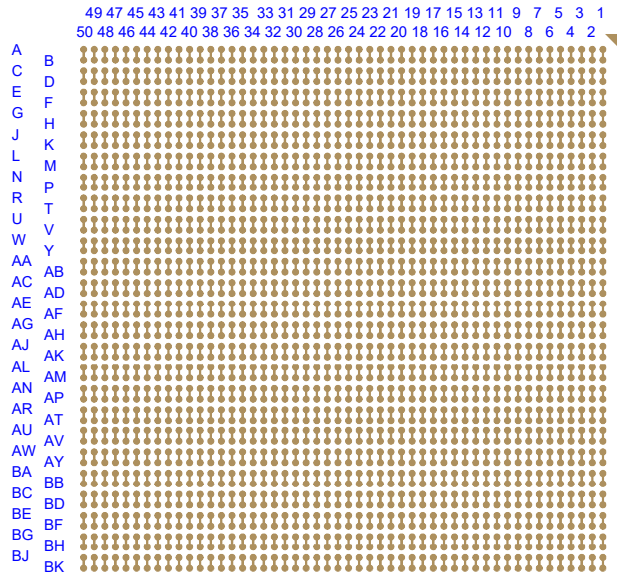

### TEST VEHICLE BOARD

### BOTTOM SIDE (TOP X-RAY VIEW)

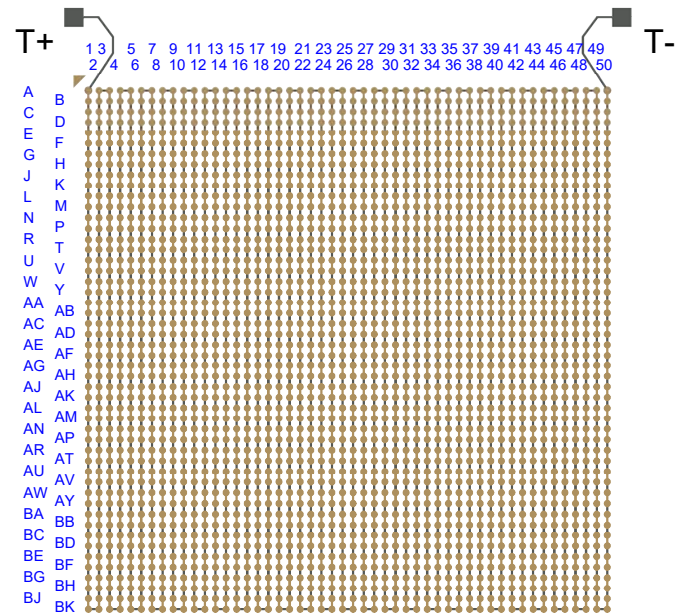
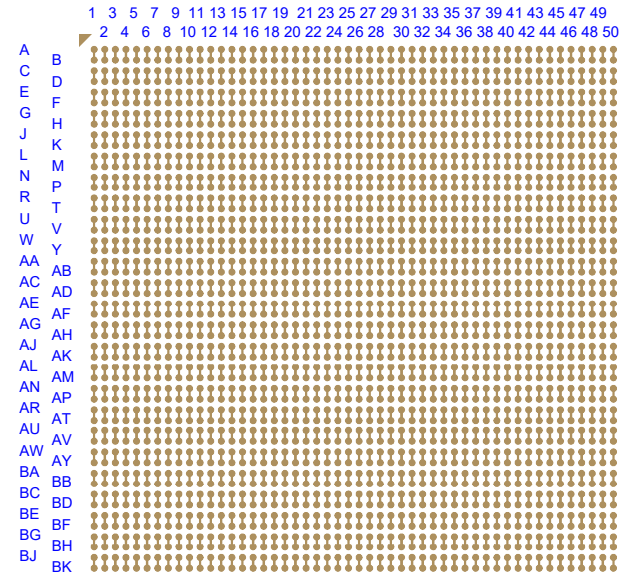

### AFTER MOUNTING

**Notes:**

- 1) PCB BOARD DIMENSIONS ARE PRESENTED ONLY AS A GUIDELINE. DESIGNERS SHOULD USE THEIR OWN EXPERIENCE WHEN DESIGNING PCB.
- 2) PCB Cu BALL PAD DIAMETER 0.61mm (24 MIL).
- 3) PCB DAISY CHAIN TRACING LINE WIDTH 0.152mm (6 MIL).
- 4) SMD (SOLDER MASK DEFINED) PAD OPENING: 0.45mm (17.7 MIL).



TITLE			
SBGA2500T.8-DC508D DAISY CHAIN DUMMY			
SCALE	SIZE	DRAWING NO.	REV
1.4:1	A	585085	A
DO NOT SCALE DRAWING			SHEET 2 OF 10

# BALL VIEW

49 47 45 43 41 39 37 35 33 31 29 27 25 23 21 19 17 15 13 11 9 7 5 3 1  
 50 48 46 44 42 40 38 36 34 32 30 28 26 24 22 20 18 16 14 12 10 8 6 4 2

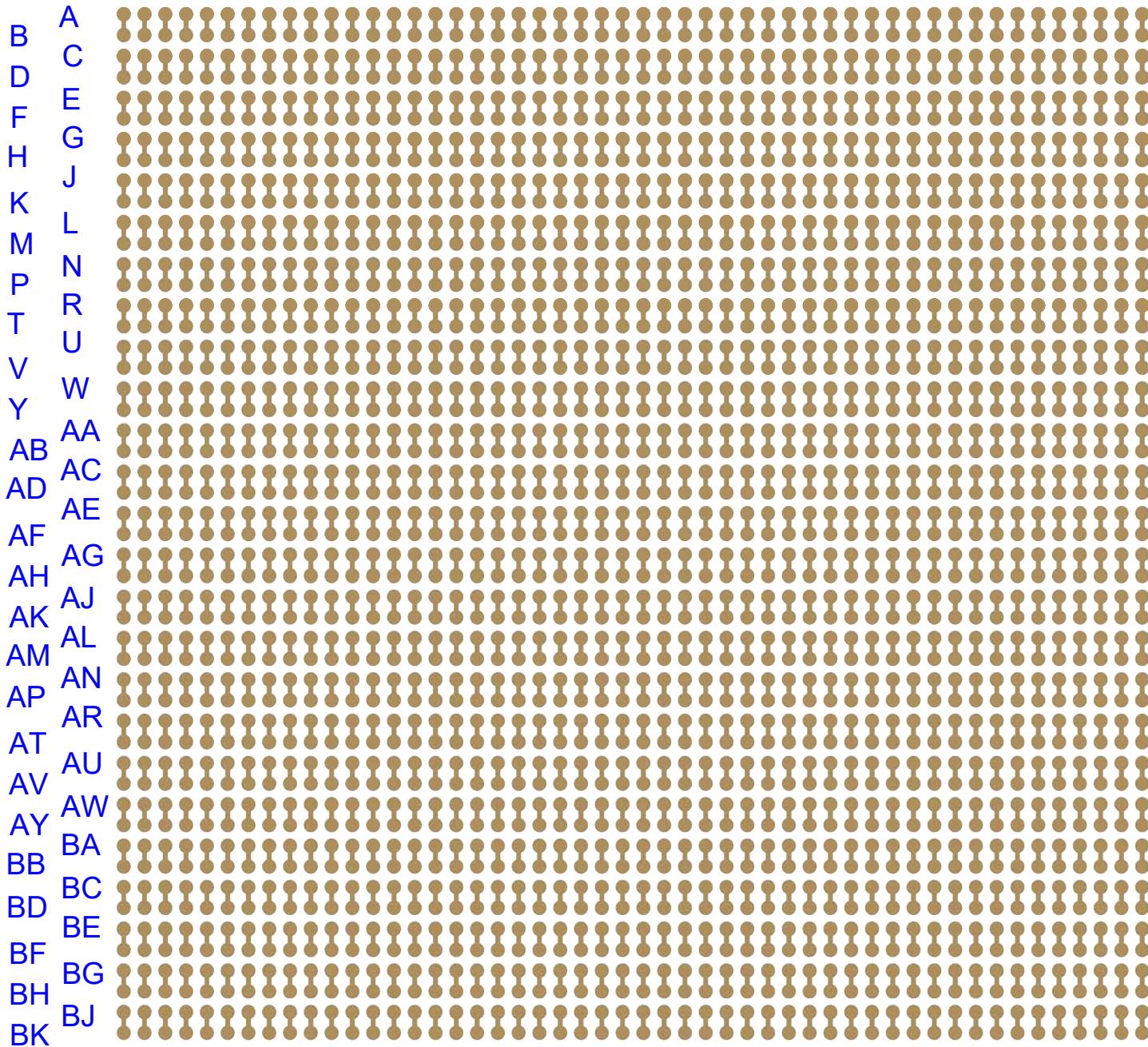

<b>TopLine®</b>			
TITLE		SBGA2500T.8-DC508D DAISY CHAIN DUMMY	
SCALE	SIZE	DRAWING NO.	REV
1.4:1	A	585085	A
DO NOT SCALE DRAWING			SHEET 3 OF 10

# BOTTOM SIDE (TOP X-RAY VIEW)

1 3 5 7 9 11 13 15 17 19 21 23 25 27 29 31 33 35 37 39 41 43 45 47 49  
 2 4 6 8 10 12 14 16 18 20 22 24 26 28 30 32 34 36 38 40 42 44 46 48 50

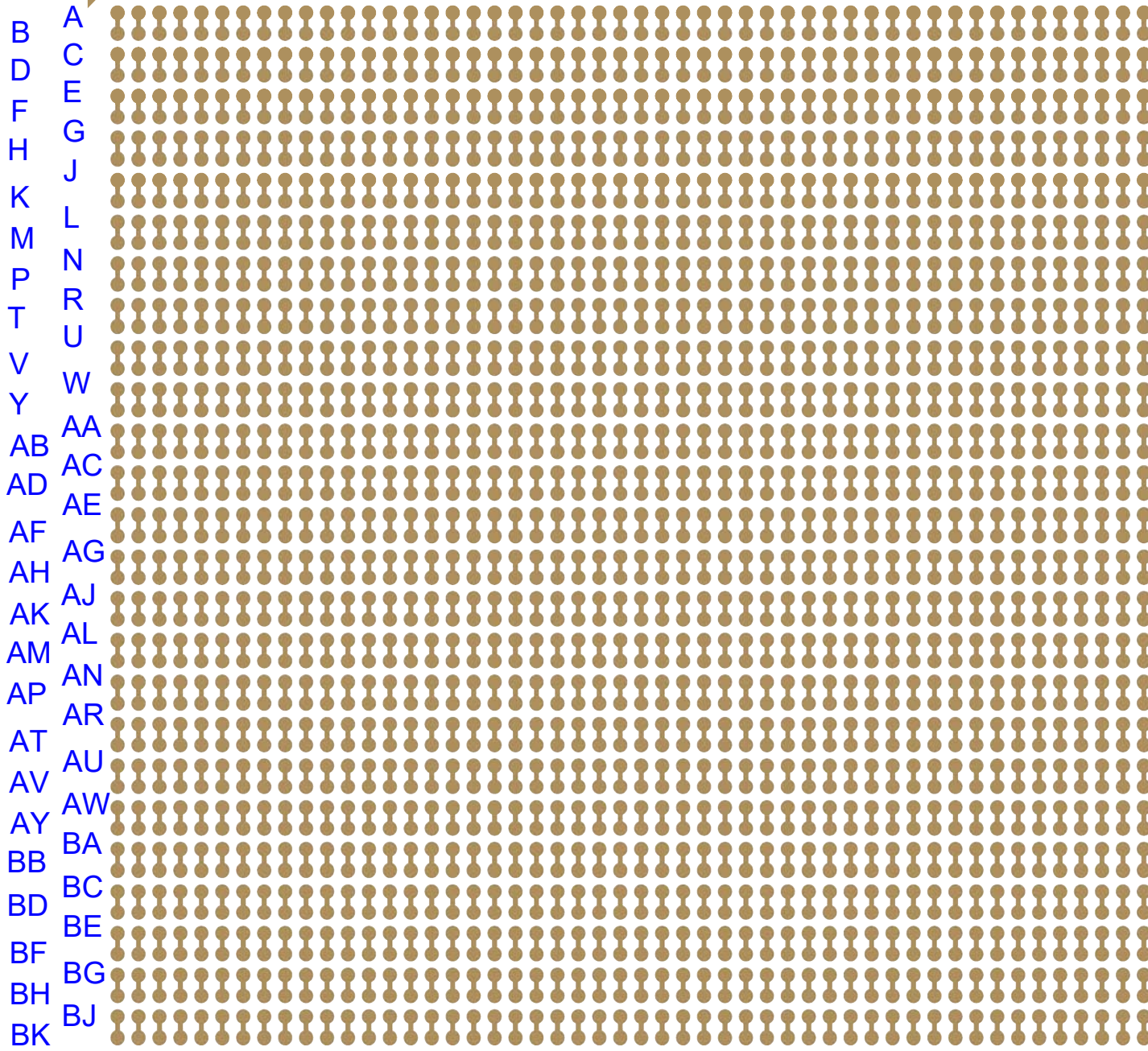

<b>TopLine®</b>			
TITLE SBGA2500T.8-DC508D DAISY CHAIN DUMMY			
SCALE 1.4:1	SIZE A	DRAWING NO. 585085	REV A
DO NOT SCALE DRAWING			SHEET 4 OF 10

# TEST VEHICLE BOARD

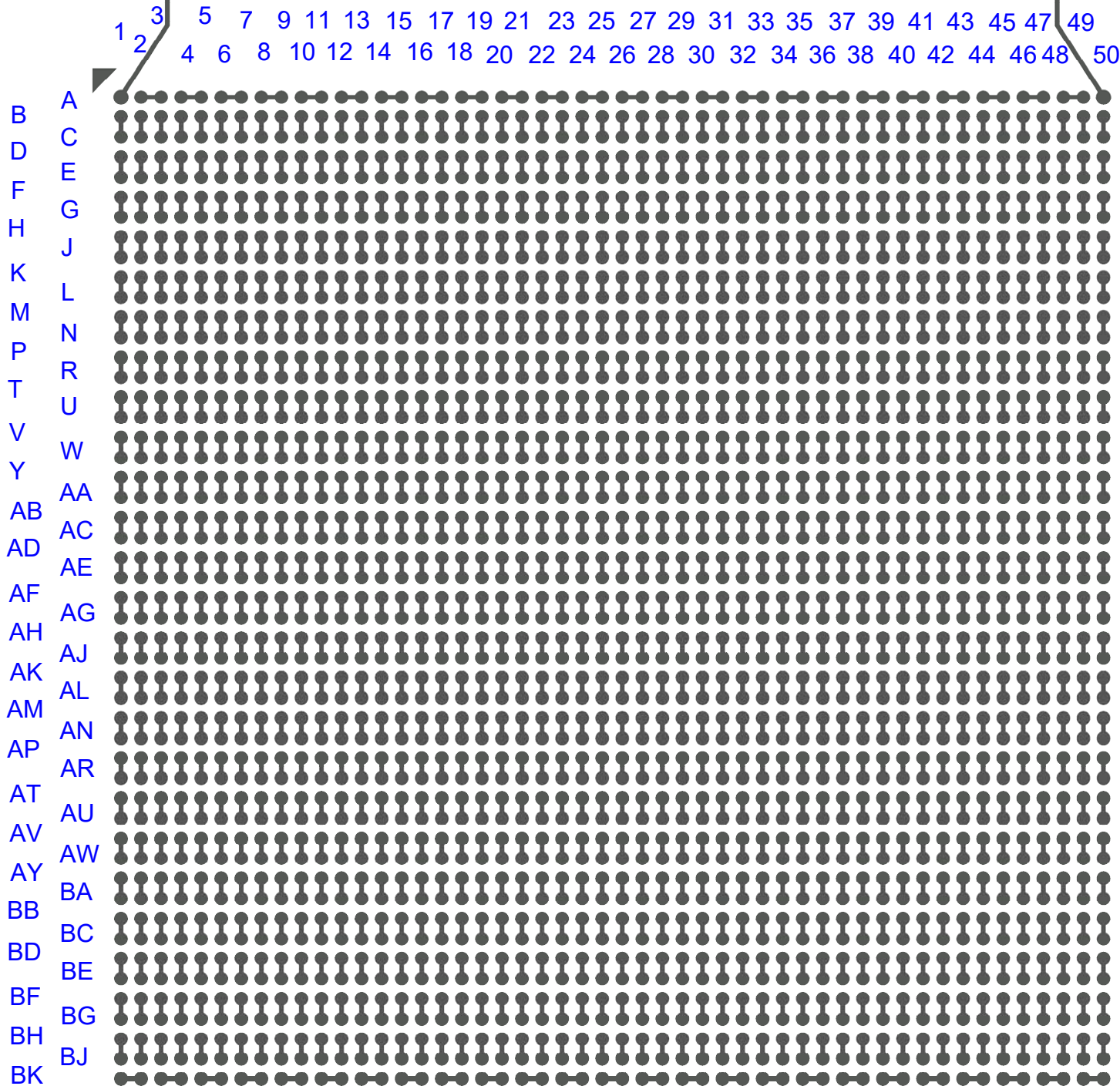

- NOTES:
- 1) PCB BOARD DIMENSIONS ARE PRESENTED ONLY A GUIDELINE. DESIGNERS SHOULD USE THEIR OWN KNOWLEDGE BASE WHEN DESIGNING THE PCB.
  - 2) PCB Cu BALL PADS DIAMETER 0.61mm (24 MIL)
  - 3) PCB DAISY CHAIN TRACING LINE WIDTH 0.152mm (6 MIL)
  - 4) SMD (SOLDER MASK DEFINED) PAD OPENING 0.45MM (17.7 MIL)
  - 5) VIA IN PAD OPTIONAL

**TopLine®**

TITLE SBGA2500T.8-DC508D  
DAISY CHAIN DUMMY

SCALE 1.4:1	SIZE A	DRAWING NO. 585085	REV A
----------------	-----------	-----------------------	----------

DO NOT SCALE DRAWING

SHEET 5 OF 10

# AFTER MOUNTING

1 2 3 4 5 6 7 8 9 10 11 12 13 14 15 16 17 18 19 20 21 22 23 24 25 26 27 28 29 30 31 32 33 34 35 36 37 38 39 40 41 42 43 44 45 46 47 48 49 50

B  
D  
F  
H  
K  
M  
P  
T  
V  
Y  
AB  
AD  
AF  
AH  
AK  
AM  
AP  
AT  
AV  
AY  
BB  
BD  
BF  
BH  
BK

A  
C  
E  
G  
J  
L  
N  
R  
U  
W  
AA  
AC  
AE  
AG  
AJ  
AL  
AN  
AR  
AU  
AW  
BA  
BC  
BE  
BG  
BJ

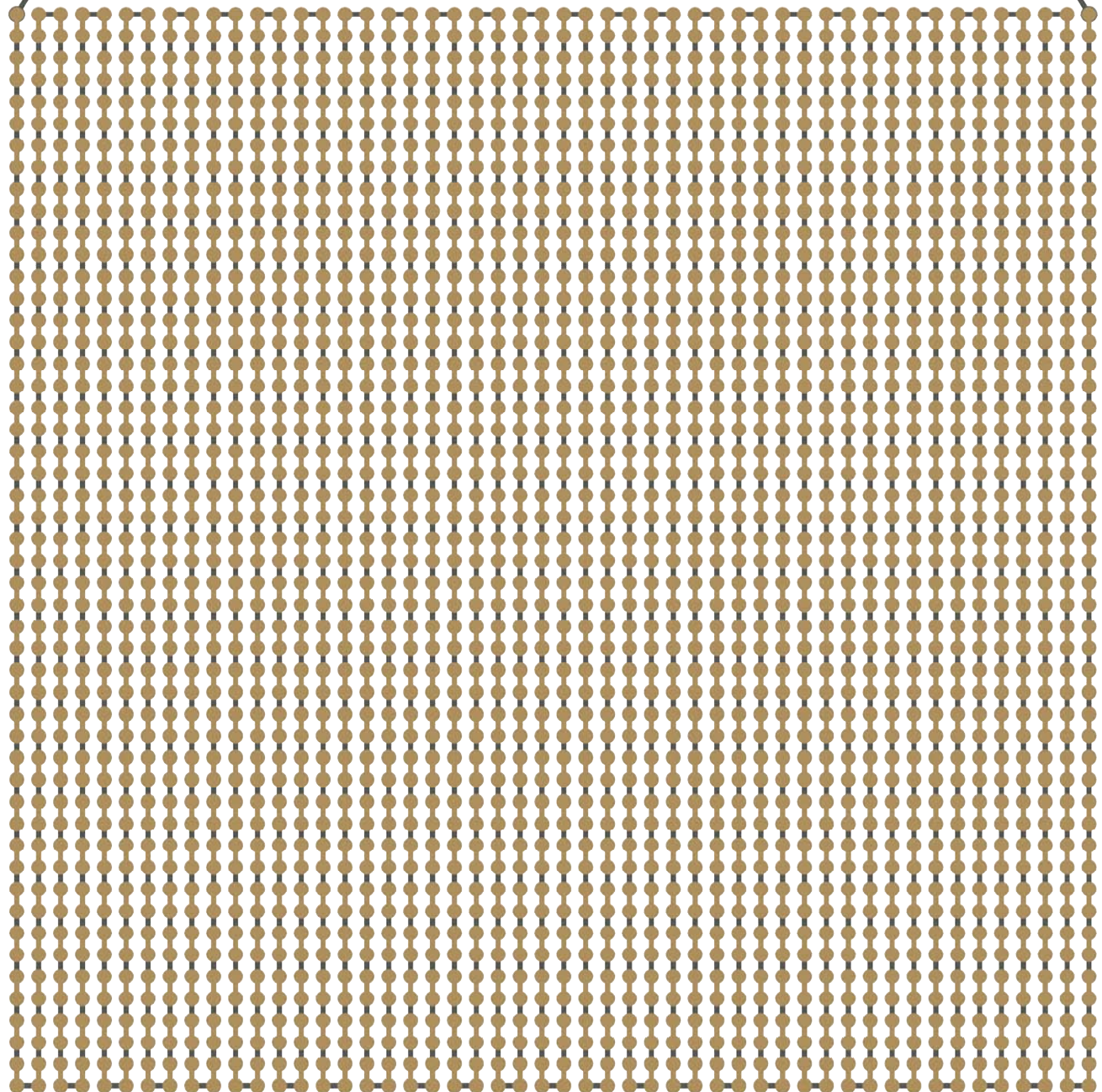

<b>TopLine®</b>			
TITLE		SBGA2500T.8-DC508D DAISY CHAIN DUMMY	
SCALE	SIZE	DRAWING NO.	REV
1.4:1	A	585085	A
DO NOT SCALE DRAWING			SHEET 6 OF 10

# MODEL TOP VIEW

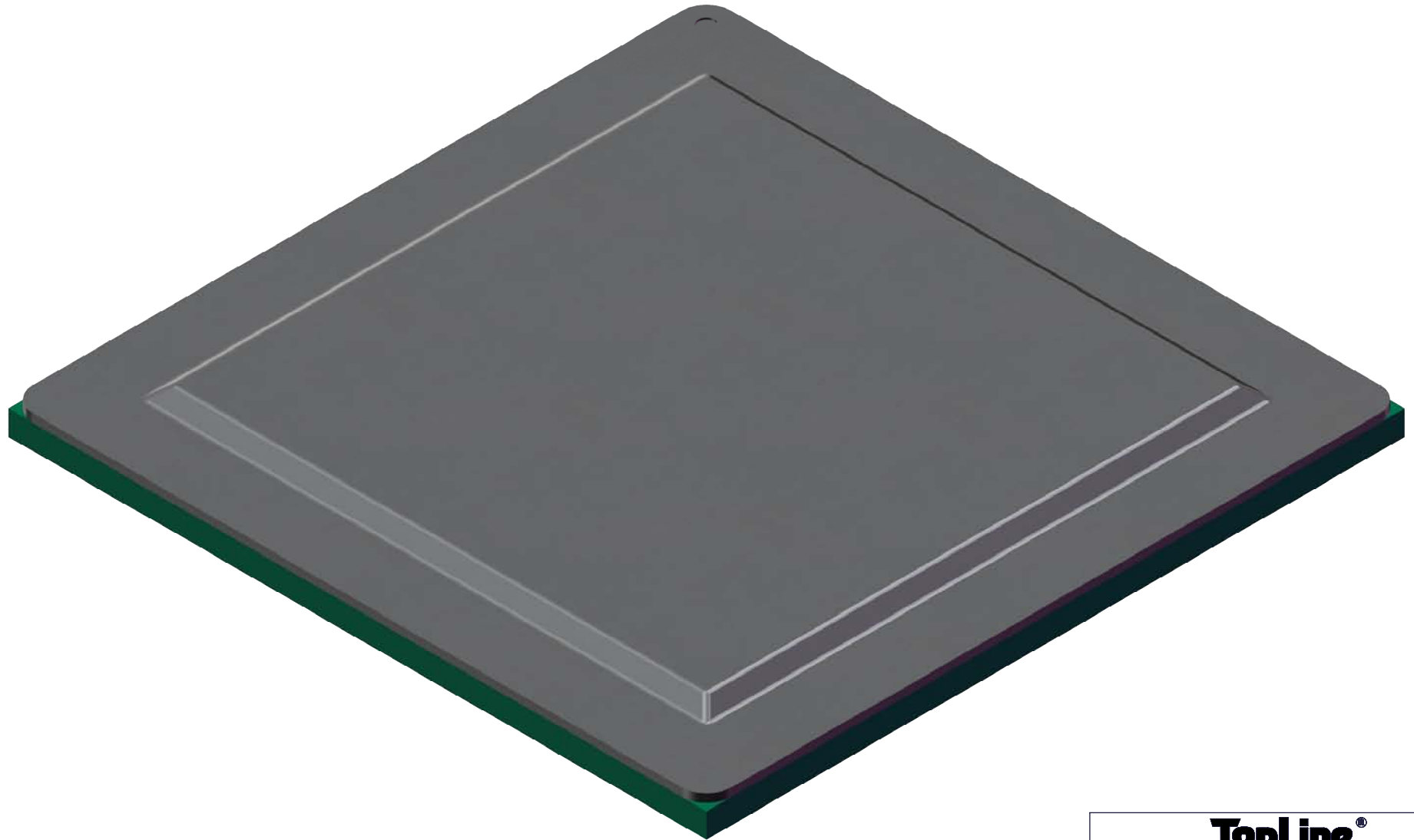

<b>TopLine<sup>®</sup></b>			
TITLE		SBGA2500T.8-DC508D DAISY CHAIN DUMMY	
SCALE	SIZE	DRAWING NO.	REV
1.4:1	A	585085	A
DO NOT SCALE DRAWING			SHEET 7 OF 10

# MODEL BALL VIEW

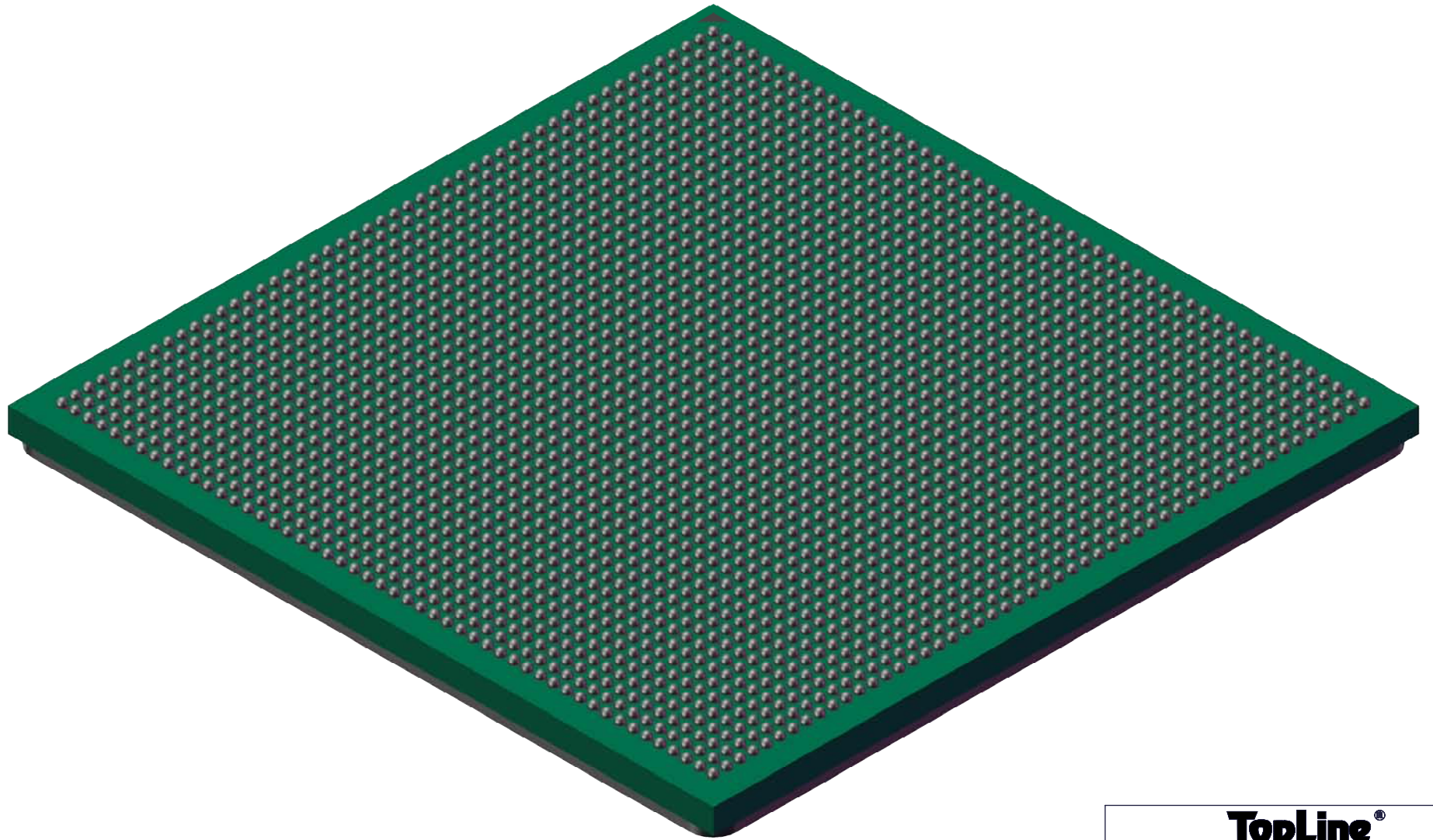

**TopLine**<sup>®</sup>

TITLE SBGA2500T.8-DC508D  
DAISY CHAIN DUMMY

SCALE 1.4:1	SIZE A	DRAWING NO. 585085	REV A
----------------	-----------	-----------------------	----------

DO NOT SCALE DRAWING

SHEET 8 OF 10



# HEAT SPREADER

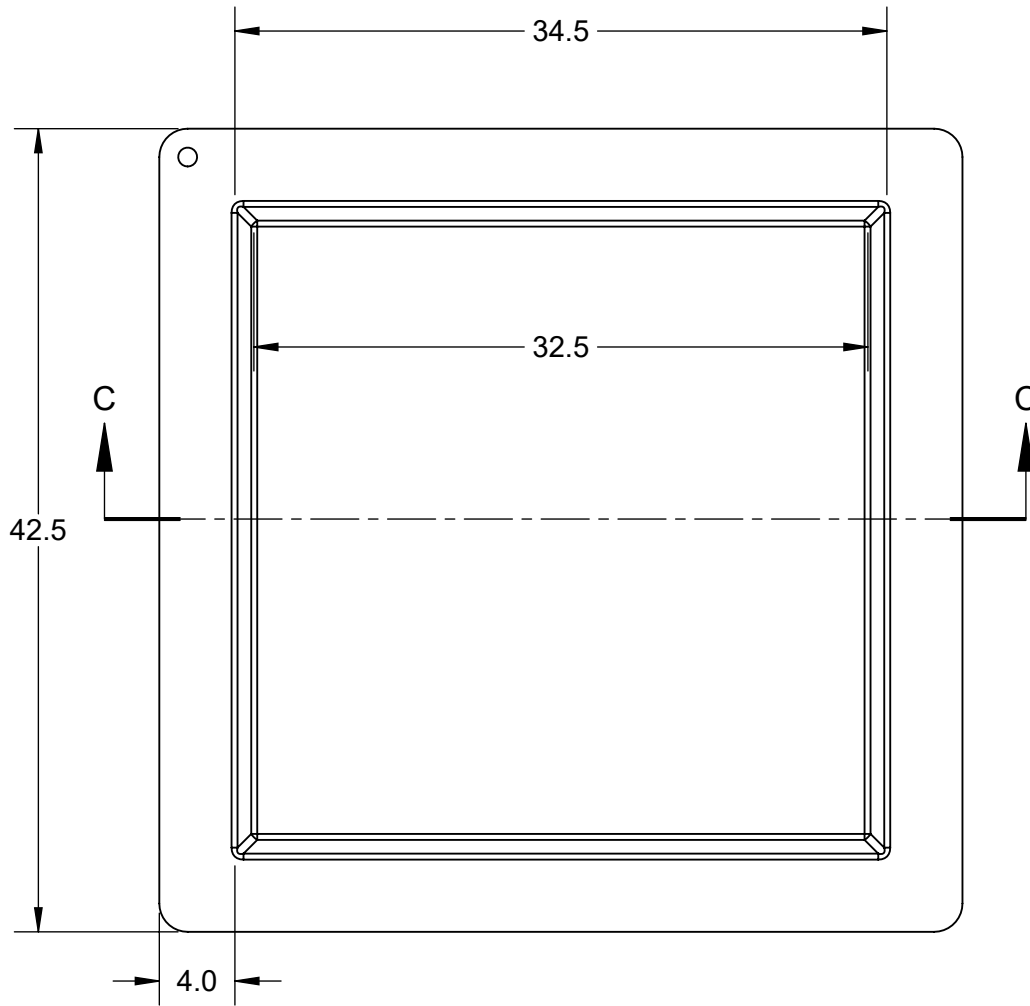

TOP

MODEL



CAVITY

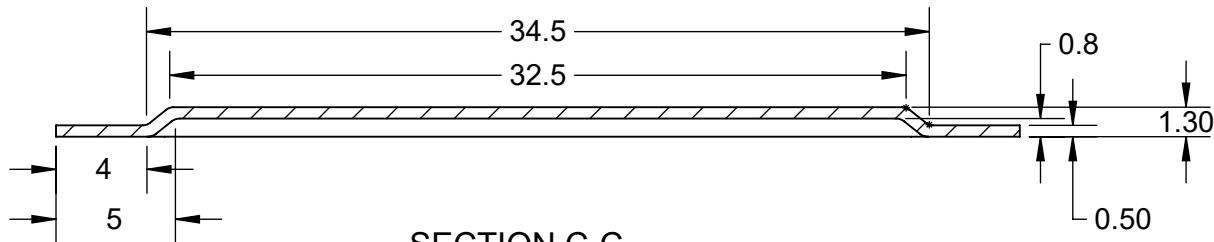

SECTION C-C  
SCALE 3 : 1

**TopLine**<sup>®</sup>

TITLE SBGA2500T.8-DC508D  
DAISY CHAIN DUMMY

SCALE	SIZE	DRAWING NO.	REV
2:1	A	585085	A

DO NOT SCALE DRAWING

SHEET 9 OF 10

# BOTTOM SOLDER MASK (RIGHT READING)

49 47 45 43 41 39 37 35 33 31 29 27 25 23 21 19 17 15 13 11 9 7 5 3 1  
50 48 46 44 42 40 38 36 34 32 30 28 26 24 22 20 18 16 14 12 10 8 6 4 2

A  
B  
C  
D  
E  
F  
G  
H  
J  
K  
L  
M  
N  
P  
R  
T  
U  
V  
W  
Y  
AA  
AB  
AC  
AD  
AE  
AF  
AG  
AH  
AJ  
AK  
AL  
AM  
AN  
AP  
AR  
AT  
AU  
AV  
AW  
AY  
BA  
BB  
BC  
BD  
BE  
BF  
BG  
BH  
BJ  
BK

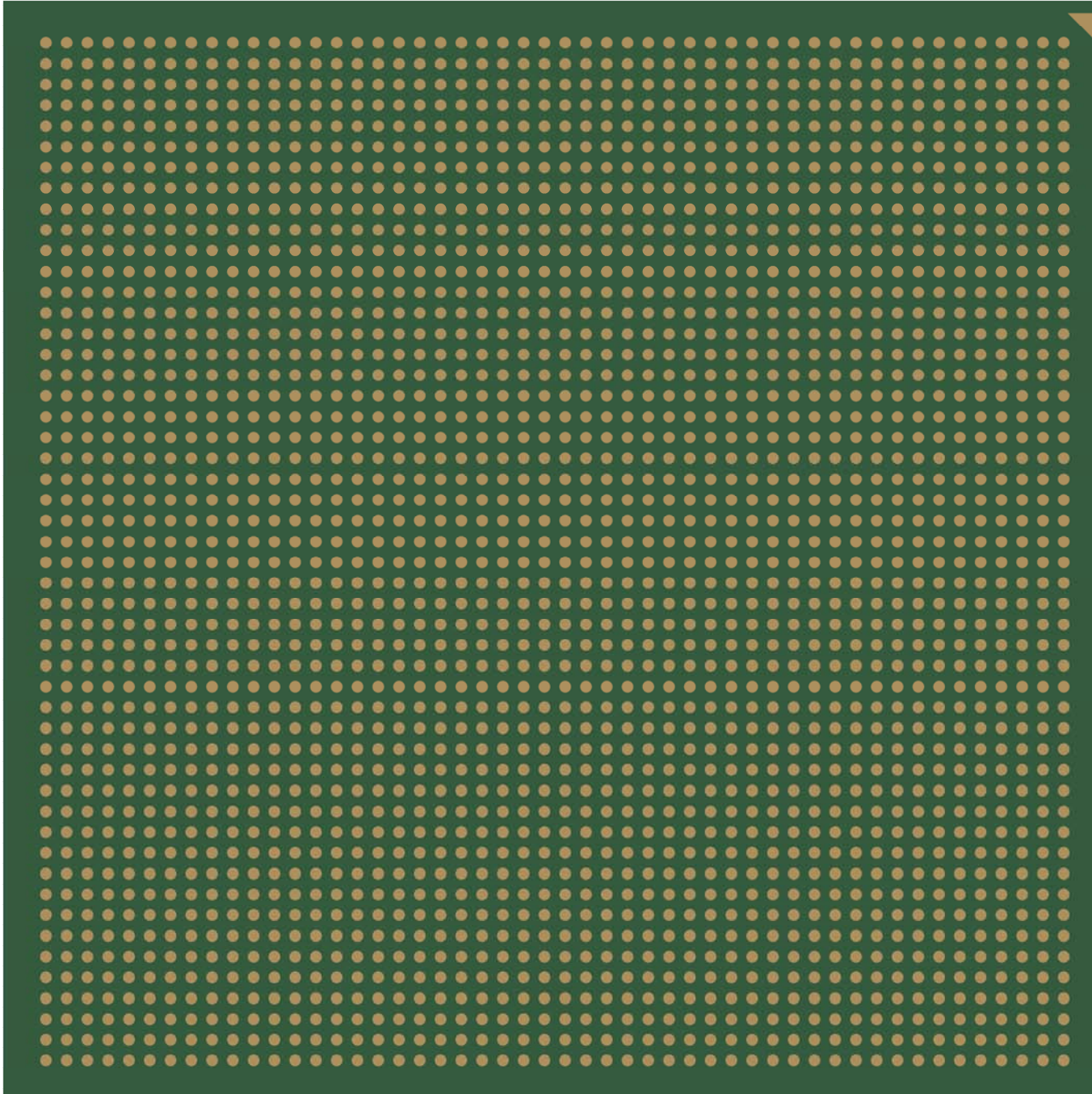

<b>TopLine®</b>			
TITLE		SBGA2500T.8-DC508D DAISY CHAIN DUMMY	
SCALE	SIZE	DRAWING NO.	REV
1.4:1	A	585085	A
DO NOT SCALE DRAWING			SHEET 10 OF 10